

SHINDENGEN

Schottky Rectifiers (SBD)

Dual

SF20JC6

60V 20A

OUTLINE DIMENSIONS

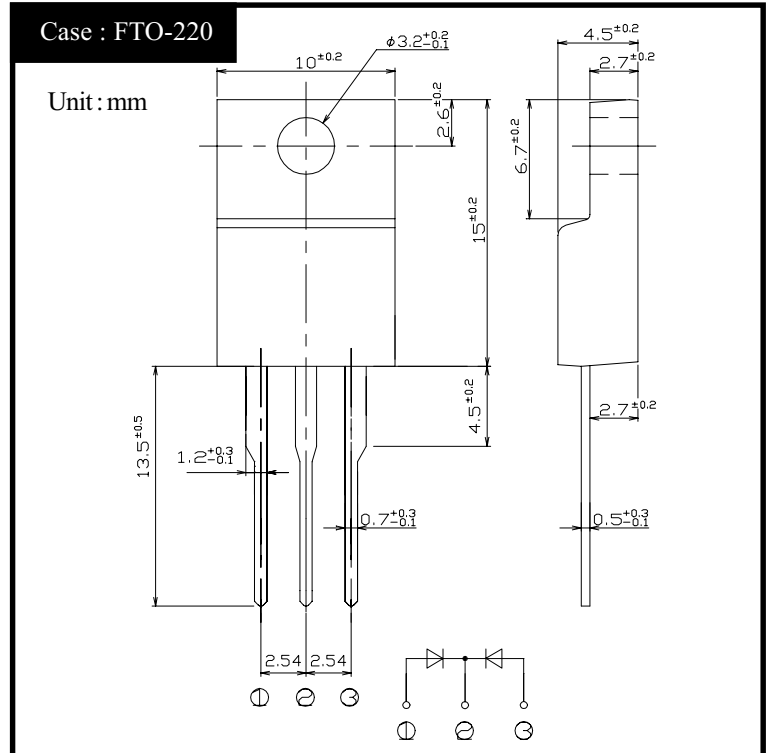

RATINGS

● Absolute Maximum Ratings (Unless otherwise specified, $T_c=25^\circ\text{C}$)

Item	Symbol	Conditions	Ratings	Unit
Storage Temperature	T_{stg}		-55~150	$^\circ\text{C}$
Operating Junction Temperature	T_j		150	$^\circ\text{C}$
Maximum Reverse Voltage	V_{RM}		60	V
Repetitive Peak Surge Reverse Voltage	V_{RRSM}	Pulse width 0.5ms, duty 1/40	65	V
Average Rectified Forward Current	I_o	50Hz sine wave, R-load, Rating for each diode $I_o/2$, $T_c=115^\circ\text{C}$	20	A
Peak Surge Forward Current	I_{FSM}	50Hz sine wave, Non-repetitive 1 cycle peak value, $T_j=25^\circ\text{C}$	200	A
Dielectric Strength	V_{dis}	Terminals to case, AC 1 minute	2	kV
Mounting Torque	TOR	(Recommended torque: $0.3\text{N}\cdot\text{m}$)	0.5	$\text{N}\cdot\text{m}$

● Electrical Characteristics (Unless otherwise specified, $T_c=25^\circ\text{C}$)

Item	Symbol	Conditions	Ratings	Unit
Forward Voltage	V_F	$I_F=10\text{A}$, Pulse measurement, Rating of per diode	Max 0.69	V
Reverse Current	I_R	$V_R=V_{RM}$, Pulse measurement, Rating of per diode	Max 0.7	mA
Junction Capacitance	C_j	$f=1\text{MHz}$, $V_R=10\text{V}$, Rating of per diode	Typ 335	pF
Thermal Resistance	θ_{jc}	junction to case	Max 2.0	$^\circ\text{C}/\text{W}$

SF20JC6 Forward Voltage

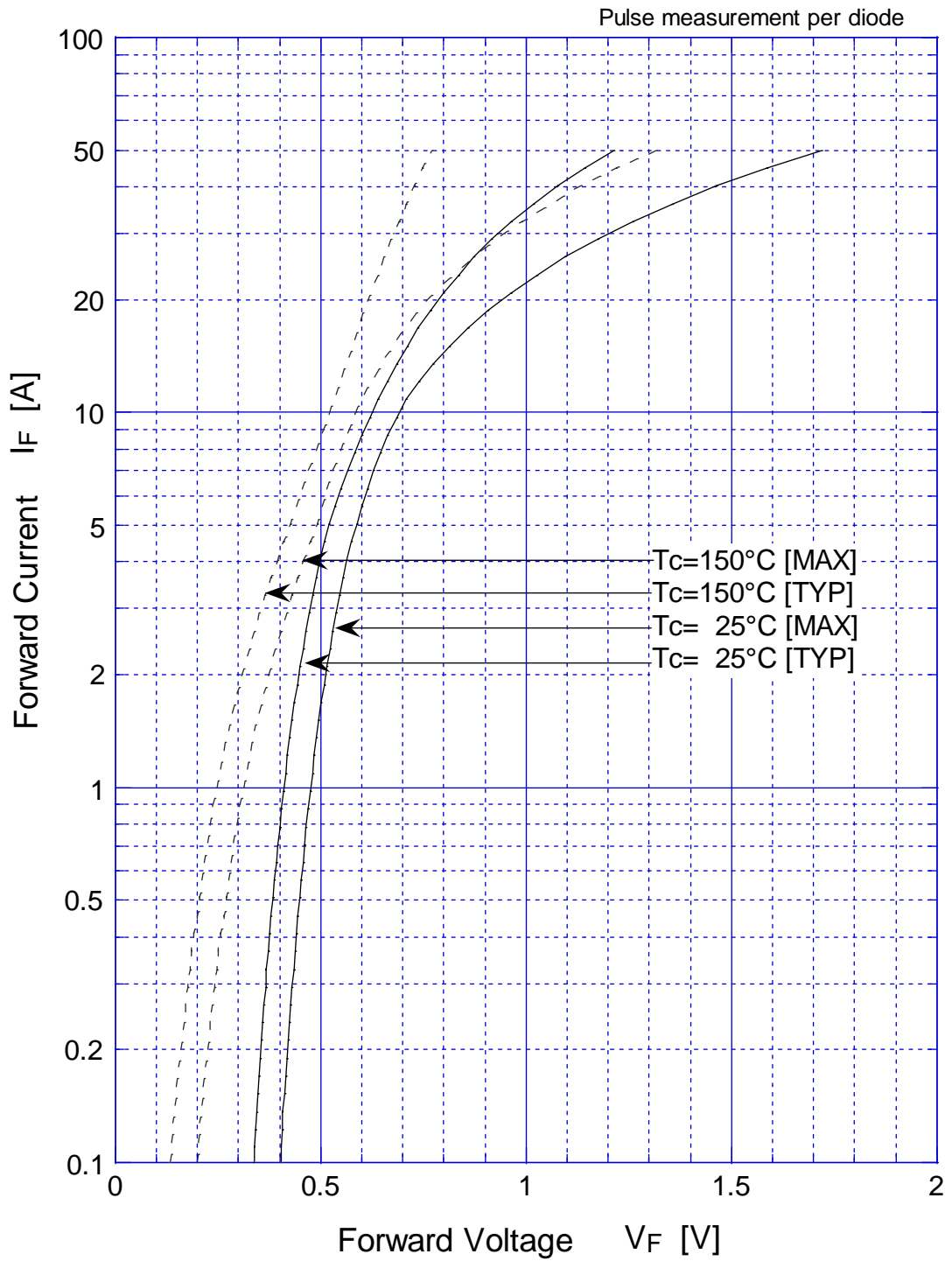

SF20JC6 Reverse Current

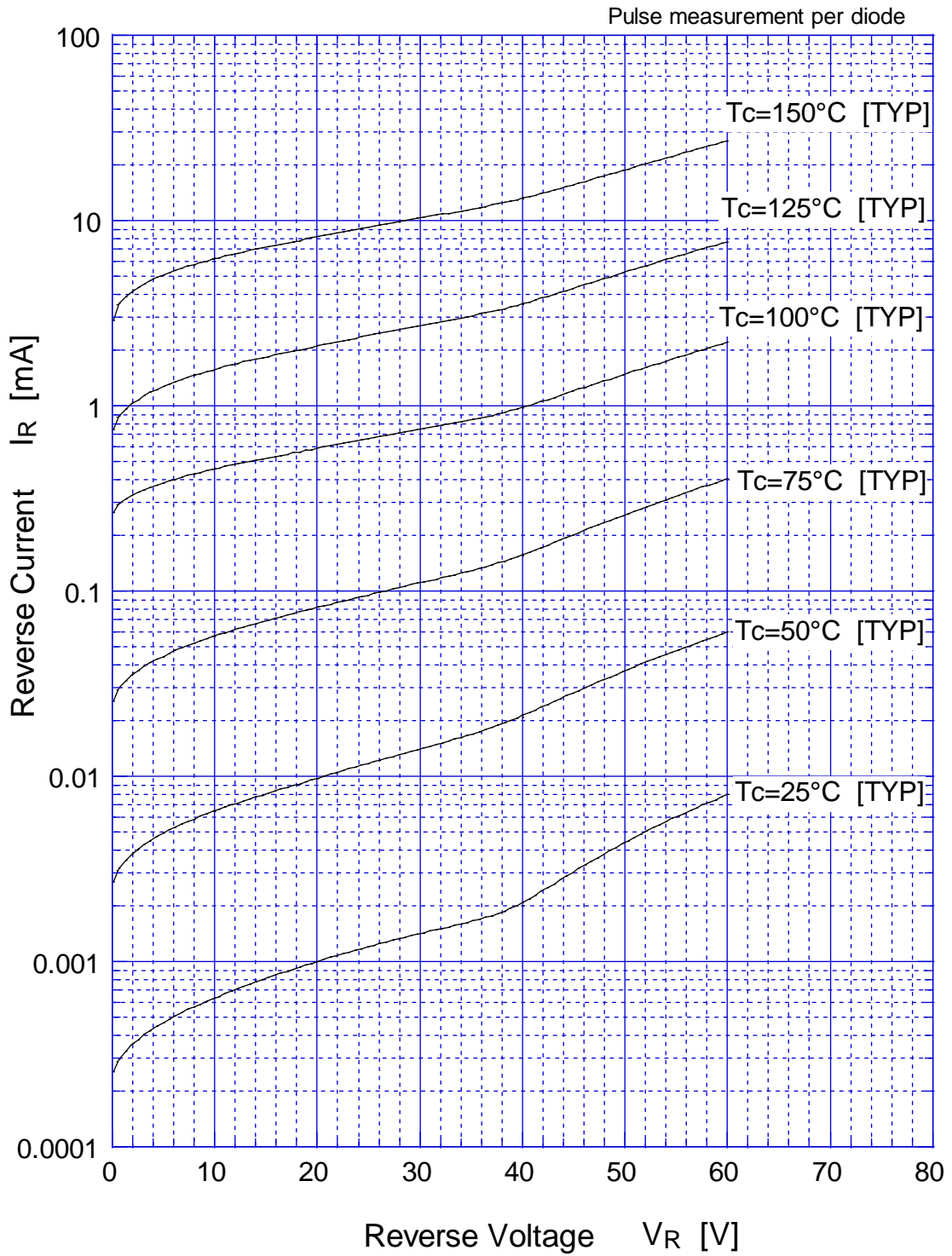

SF20JC6 Forward Power Dissipation

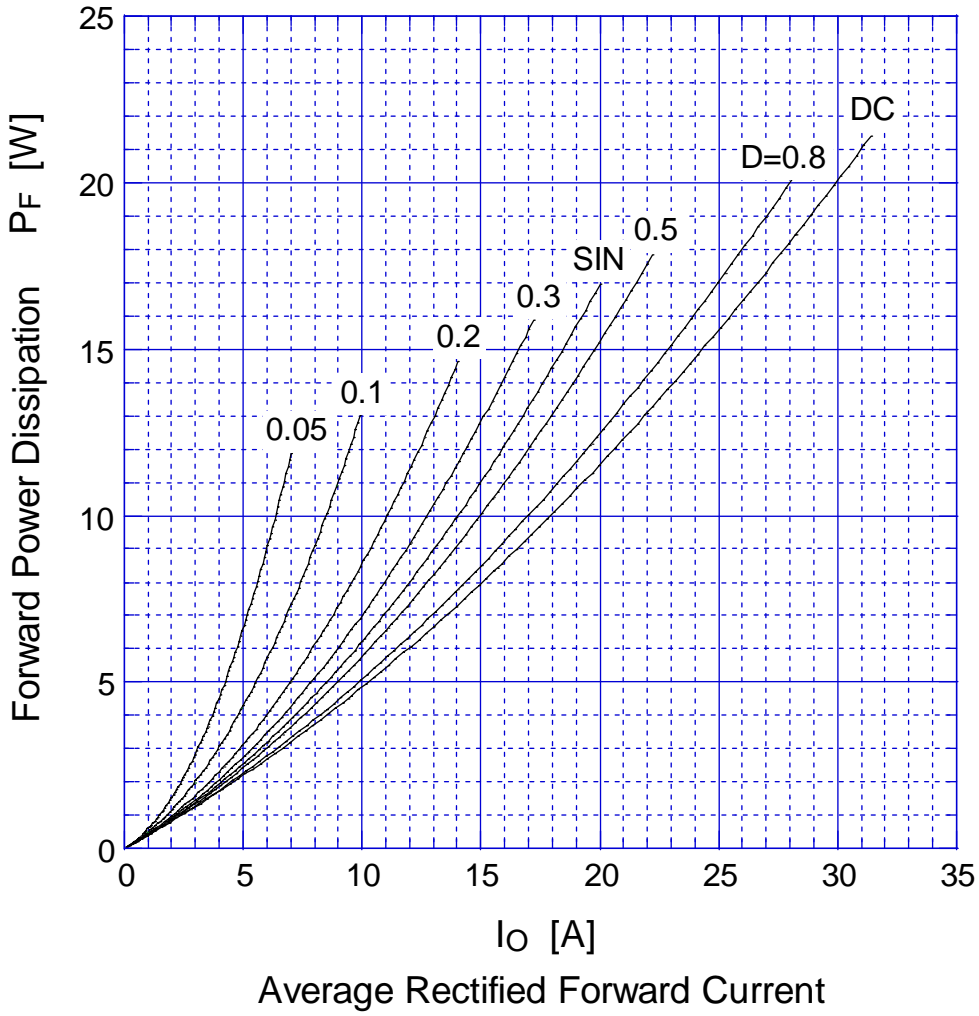

$T_j = 150^\circ\text{C}$

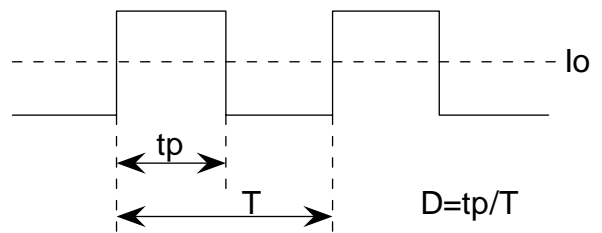

SF20JC6 Reverse Power Dissipation

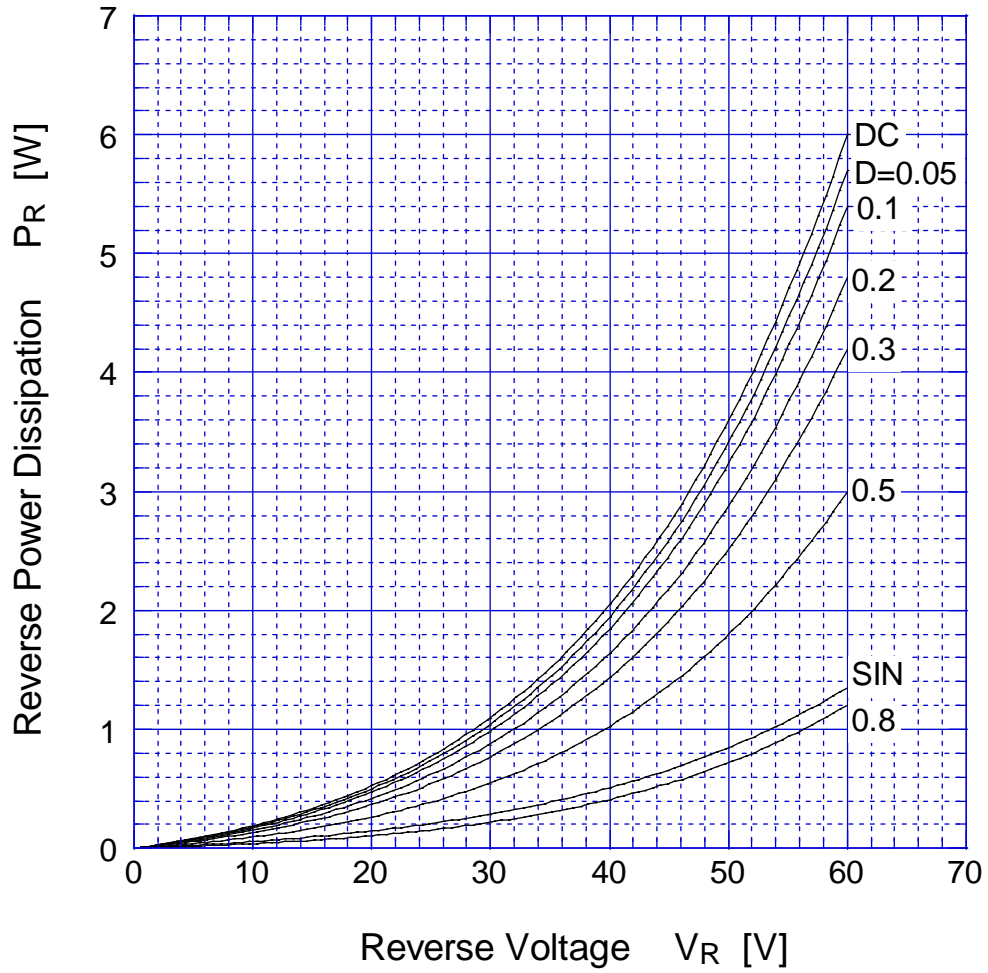

$T_j = 150^\circ\text{C}$

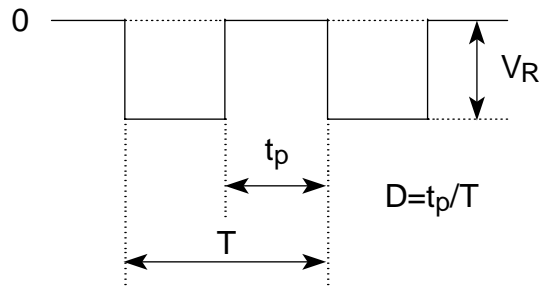

SF20JC6

Derating Curve

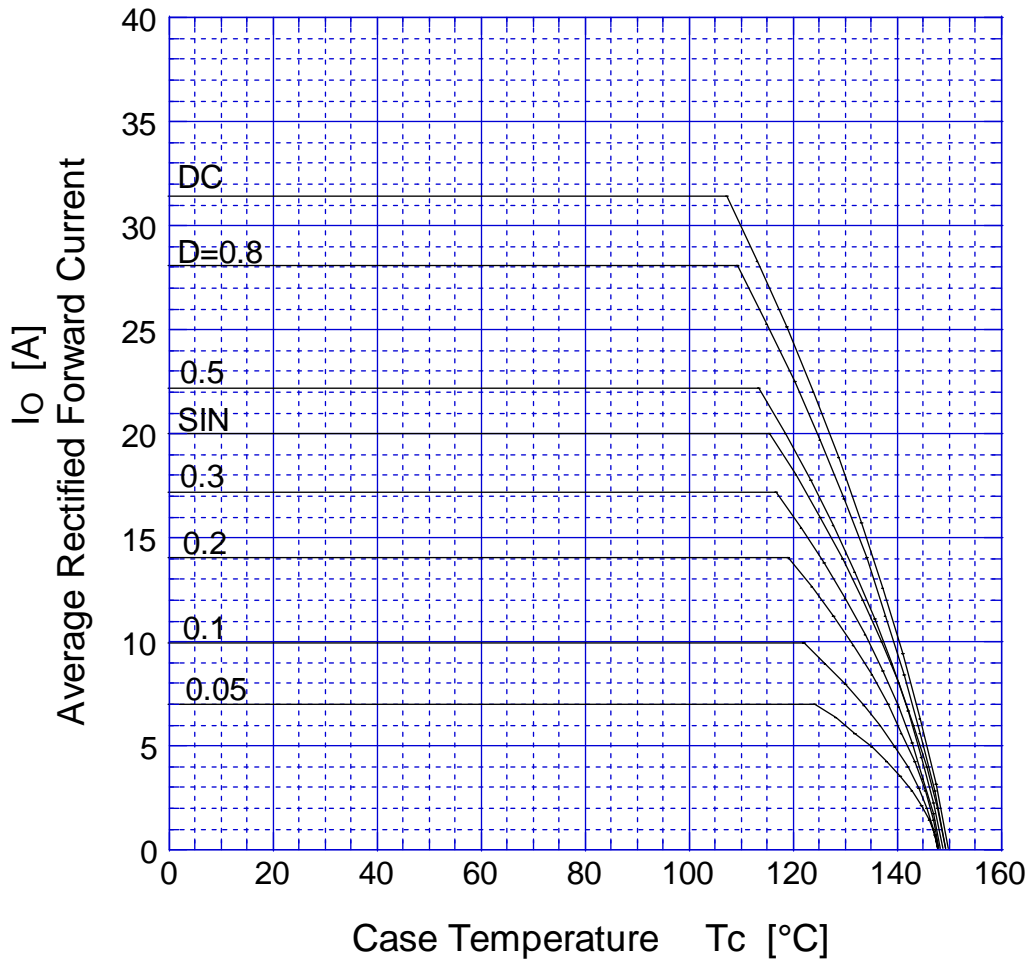

$V_R = 30V$

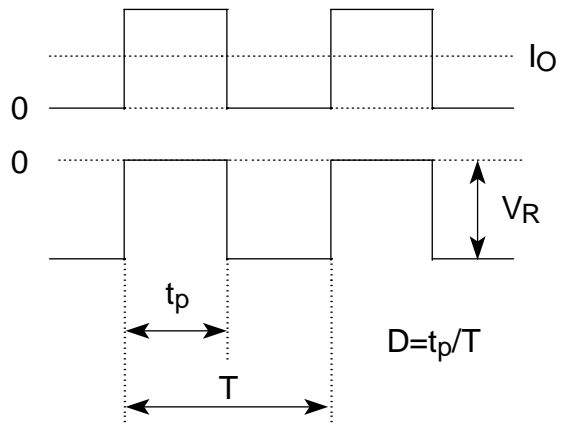

SF20JC6 Peak Surge Forward Capability

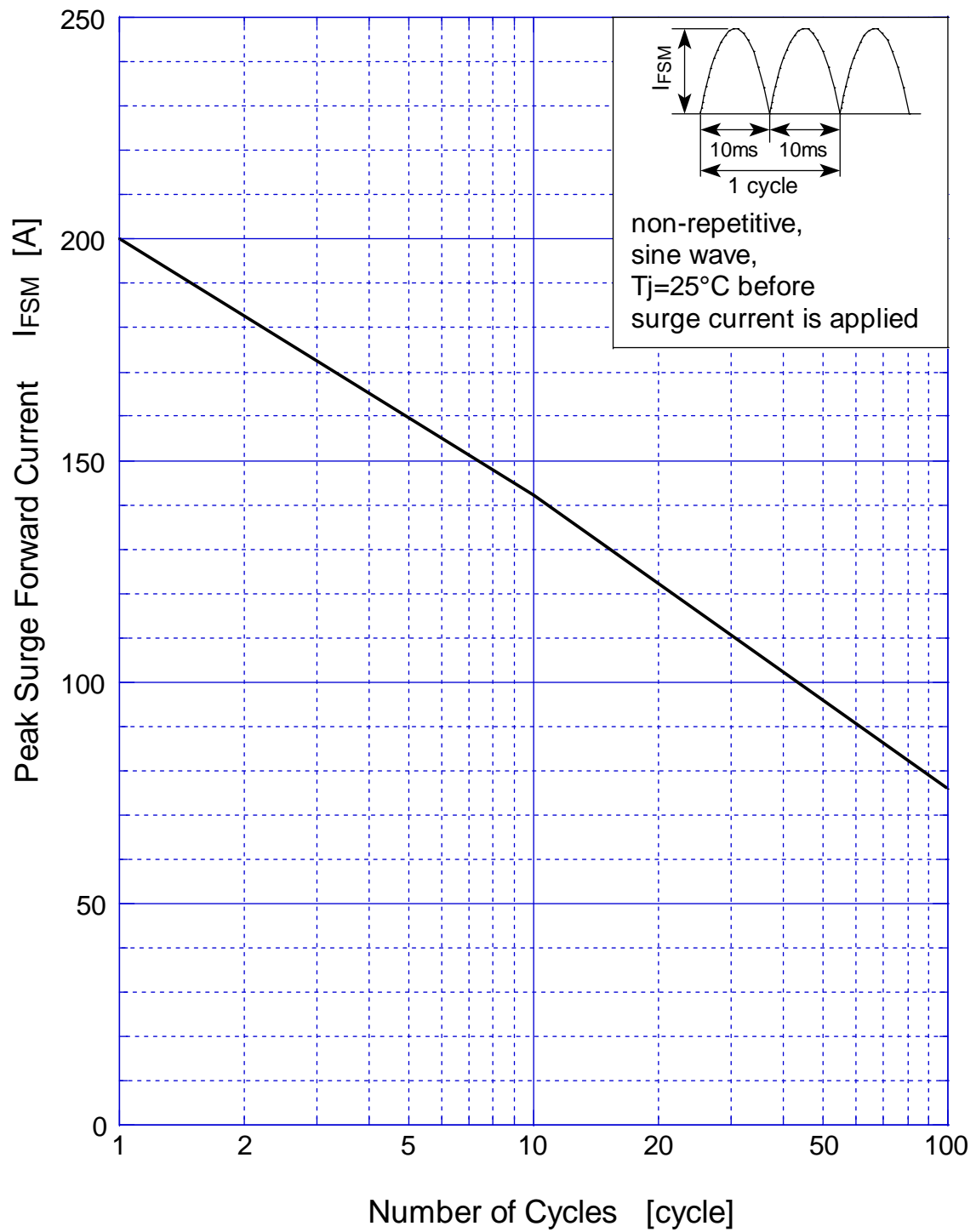

SF20JC6 Junction Capacitance

